

Punkt Lamp 150

Design: focus lighting



The design of the **Punkt Lamp** is dominated by the inner shade in mouth-blown glass, spreading the light in a pleasant and beautiful way.

The new LED versions of the Focus Punkt Lamps combine diffuse light and spot light. Thus they meet the requirements of the European standard for general lighting in indoor work places. The LED is hidden behind a diffuser, and no inside components are visible. Furthermore, the diffuser contributes to an even illumination of the glass shade, and the visual appearance of the Punkt Lamp with LED fully matches that of the conventional incandescent lamps.

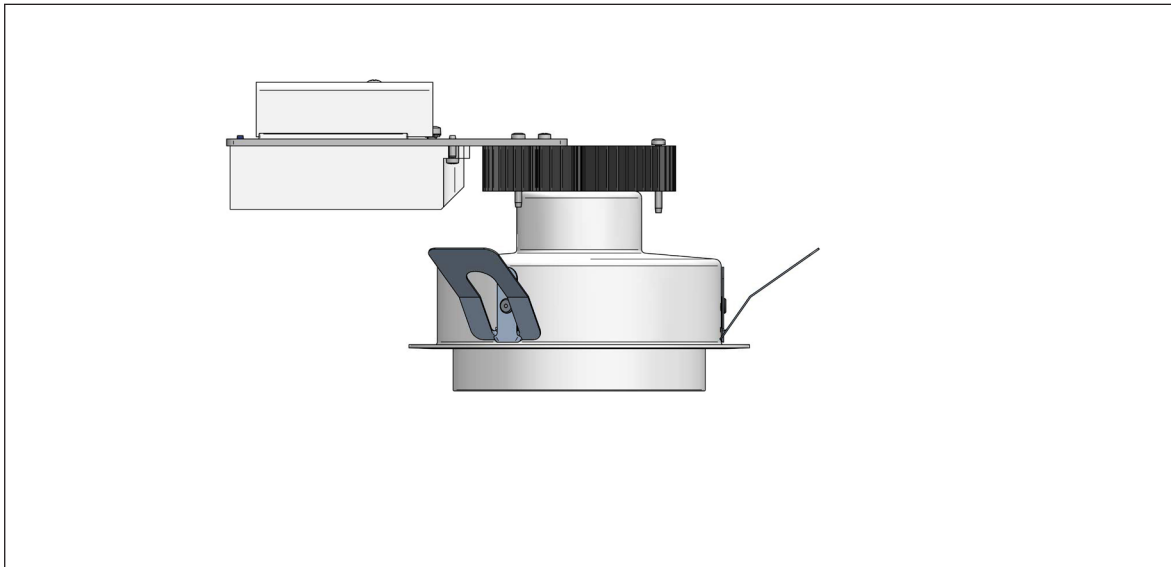

Size:

150 mm diameter

Other Punkt lamps: 65, 90, 110, and 200 mm

Finish:

White or grey metallic with shade in opal-white glass

Light sources for Punkt 150:

The 150 mm Punkt lamp is available with Bridgelux V8 LED. V8 is a compact light source with high output and true colour reproduction.

Mounting:

All Punkt lamps are approved for recession in various types of ceilings. With a special waterproof cover, they can be used in bath rooms and outdoors in roofs and carports.

Punkt Lamp 150:

11 W - Can be recessed into isolated ceilings.

16 W - Un-isolated ceilings only. 

Punkt Lamp 150 - LED

Design: focus lighting

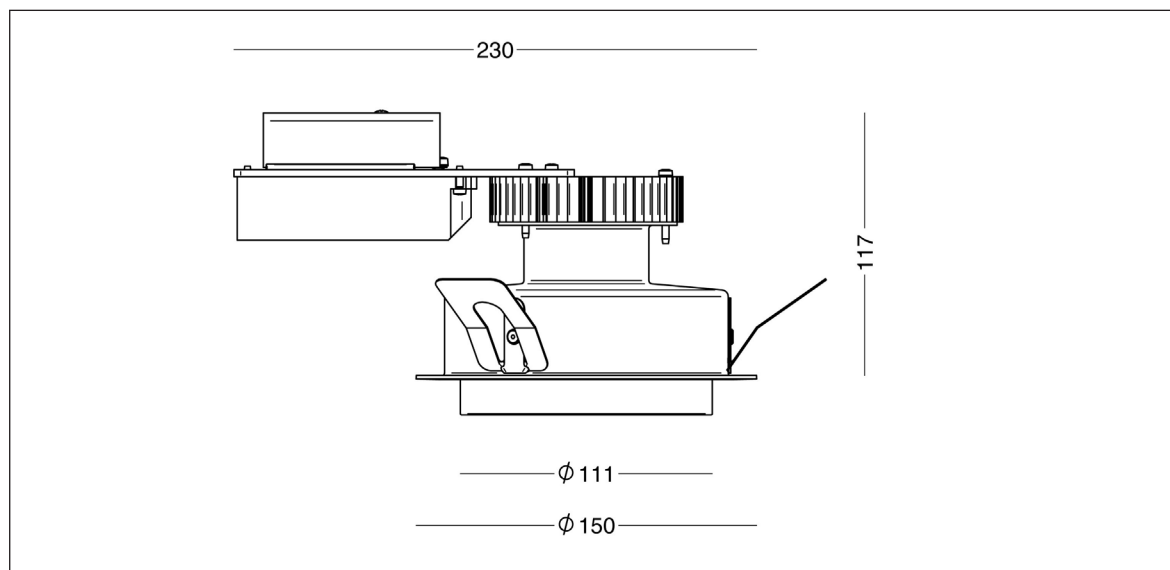

Luminaire specification:

Material: Aluminium
 Shade: Opal-white glass cylinder
 Mounting: To be recessed
 (with 16 W in unisolated ceiling only)
 Cut-out: Ø132-134 mm in 6-15 mm plates
 Ø136-138 mm in 15-35 mm plates
 Clearances: Horizontally: min 45 mm
 Height: min 117 mm from lower edge of ceiling
 Connection: 230 V, box with 5-pole terminal block
 Classification: IP20, class I
 Weight: 0.9 kg

Options: 3 mm glass shade - specification below
 Ring for soft ceilings

Lamp and driver specification:

LED type: Bridgelux V8
 Total consumption: 16 W (700 mA), alt. 11 W (500 mA)
 Operational life: min 100,000 hours at t_a max 25°C, L90B10
 Colour temperature: 2700, 3000, or 4000° Kelvin
 Energy eff. class: F
 Colour rendering: min 90 Ra
 Colour accuracy: 3 steps SDCM
 Driver: Helvar LED driver, 350-700 mA
 Option for dimmable driver
 Operational life: min 50,000 hours

Product codes

Punkt Lamp 150 LED					
Item No.	Lamp type		Select colour, colour temperature, etc in the table below.		
2893-	11 W V8, 500 mA				
2898-	16 W V8, 700 mA				
To be combined with:	Colour	Colour temperature		Dimmable driver	
	2 white w. glass	927	2700 K, 90 Ra	empty	no dimming
	9 grey metallic w. glass	930	3000 K, 90 Ra	V	1-10 V
		940	4000 K, 90 Ra	D	Dali
Example: 2898-2930V = Punkt Lamp 150, 16 W LED, 3000 K, white w. glass, dimmable 1-10 V					
Options					
20152	3 mm glass shade				
2030-20	Ring for soft ceilings				

Punkt Lamp 150 - glass shade

Design: focus lighting

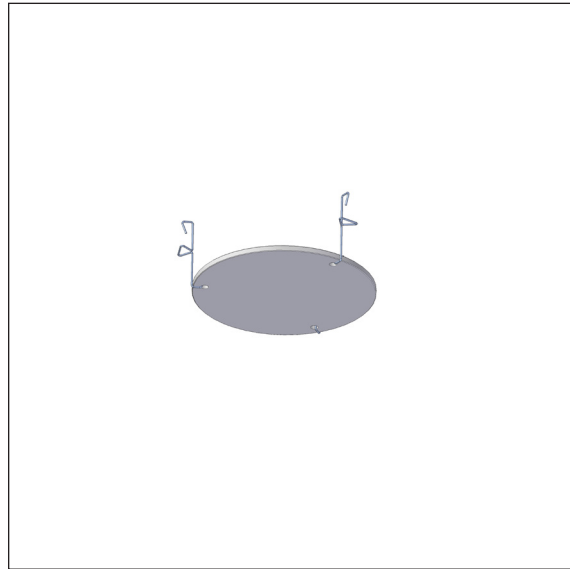
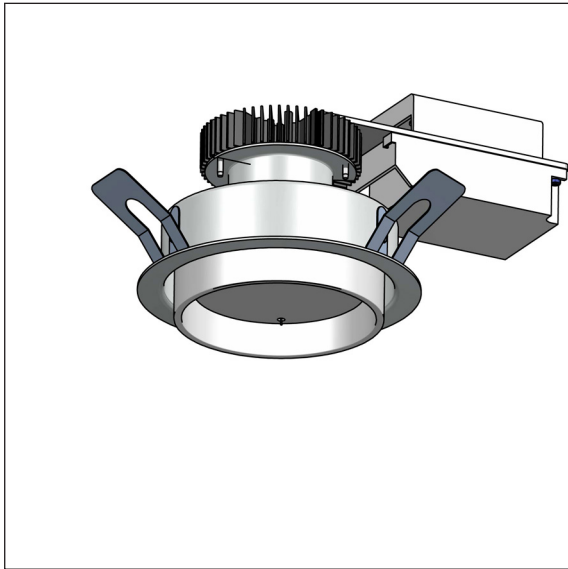

Product specification:

Material:	Sandblasted glass
Assembly:	The glass shade is attached to the inner cylinder. For replacement of lamp, cylinder and shade are dismantled in one piece.
Dimensions:	Ø 90 mm, H 3 mm
Light diffusion:	85 per cent