

Nyx 190 - LED module, V6, for bollard

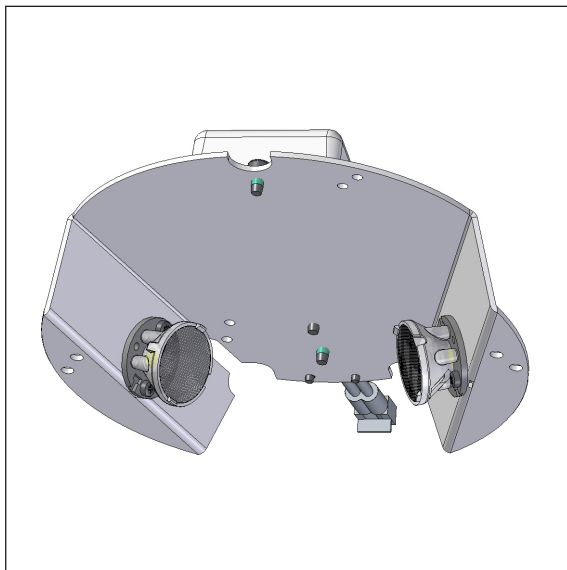

Complete LED module for easy and efficient refurbishment of existing Nyx 190 bollard luminaires.

LED and driver specification:

LED type: 2 x Bridgelux V6
 Energy consumption: 6, 8, 11 or 15W
 Operational life: min 100,000 hours at ta max 25°C, L90B10
 Colour temperature: 2700, 3000, or 4000 K, energy eff class F
 Colour rendering: min 90 Ra
 Colour accuracy: 3 Steps SDCM

Driver: LED driver, dimming or programming optional
 Operational life: min 100,000 hours

Exchange of lamp module:

Demount the plate holding the old lamp and replace it by the LED module, using the same two screws. For old versions, mount the enclosed connector in the wall box prior to replacing the LED module.

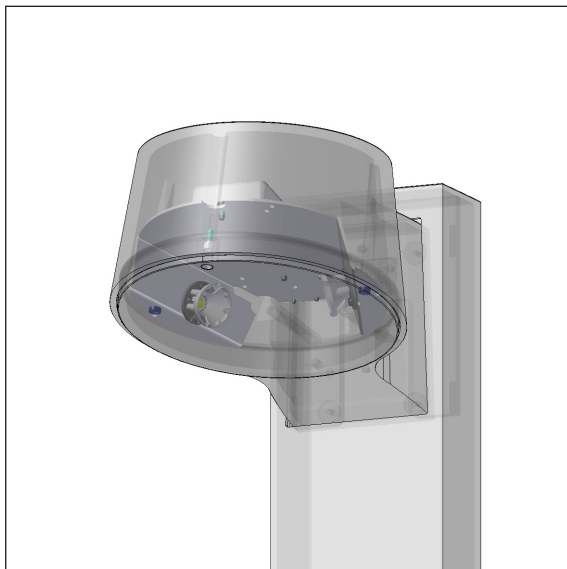

We include a blank lable in the consignment. Write the old item number on the lable and attach it inside the luminaire.

Variants:

LED module for Nyx 190 for bollard						
Item No.	Lamp type	Select colour temperature and other options in the table below.				
1973-	6 W Bridgelux V6, 250 mA					
1919-	8 W Bridgelux V6, 350 mA					
1955-	11 W Bridgelux V6, 500 mA					
1960-	15 W Bridgelux V6, 700 mA					
Combine with:	Colour temperature	Dimming		Classification		
	927 2700 K, 90 Ra	D	Dali	empty	class I	
	930 3000 K, 90 Ra	E	programmable	K	class II	
	940 4000 K, 90 Ra					
Example:	1955-930D = 11 W LED module, 3000 K, 90 Ra, Dali					
The above LED modules fit the following variants (X stands for colour code):						
	6022X, 6222X, 6522X, 6822X					
	6022, 6222, 6522, 6841, 6842, 6888					