

# Quarto 380 - LED module

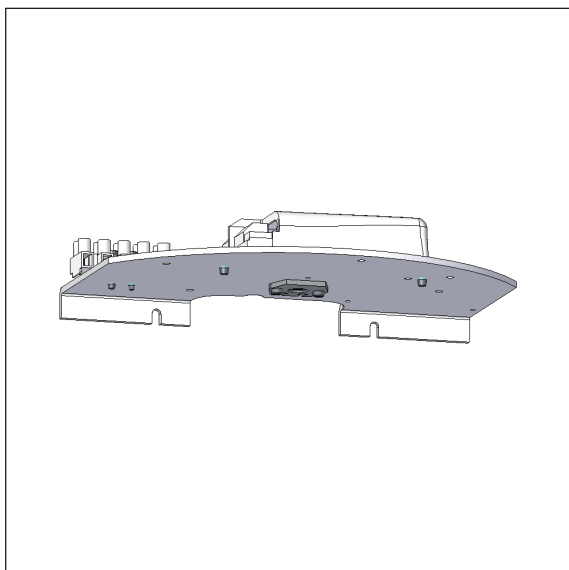

Complete LED module for easy and efficient refurbishment of existing Quarto 380 fixtures, interior and exterior.

### LED and driver specification:

LED type: Bridgelux V8  
 Energy consumption: 11 or 16 W  
 Operational life: min 100,000 hours at ta max 25°C, L90B10  
 Colour temperature: 2700, 3000 or 4000 K, energy eff. class F  
 Colour rendering: min 90 Ra  
 Colour accuracy: 3 Steps SDCM  
 Output ratio: 74 per cent  
 Driver: LED driver, dimming optional  
 Operational life: min 100,000 hours

### Exchange of lamp module:

Using a cross-point screw driver, remove the diffuser by loosening the two locking screws through the weep holes.

Remove the metal shield by loosening the two screws on the fold.

In case of fixtures for LED and CFL, loosen cables and the screws of the insert and lift it off.

In case of fixtures with reflector, loosen the two screws and lift the reflector off.

Loosen the screw to the clamp lid and remove the lid.

Fasten the new module by means of the same screws and connect the leads.

We include a blank lable in the consignment. Write the old item number on the lable and attach it inside the luminaire.



### Variants:

LED modules for Quarto 380									
Item No.	Lamp type	Select colour temperature and other options in the table below.							
1913-	11 W V8, 500 mA								
1914-	16 W V8, 700 mA								
Combine with:	Colour temperature	Dimming							
	927 2700 K, 90 Ra	V	1-10V						
	930 3000 K, 90 Ra	D	Dali						
	940 4000 K, 90 Ra	R	bluetooth sensor						
Example:	1913-930D = 11 W LED module, 3000 K, 90 Ra, Dali								
The above LED modules fit the following variants (X stands for colour code):									
Interior	404X, 414X								
	The interior variant has not been in the programme since 2000.								
Exterior	604X, 614X, 684X, 6004X, 6104X, 6204X, 6304X, 6804X, 6814X								
	6004, 6809, 6810								